

Regulation

VM iSense Pro



User Guide

Contents

1	Introduction	4
	1.1 Symbols used	4
	1.2 Abbreviations	4
	1.3 Liabilities	4
	1.3.1 Manufacturer's liability	4
	1.3.2 Installer's liability	5
	1.3.3 User's liability	5
	1.4 Certifications	6
2	Description	7
	2.1 Description of the keys	7
	2.2 Description of the display	8
	2.2.1 Key functions	8
	2.2.2 Flame symbol	8
	2.2.3 Solar (If connected)	8
	2.2.4 Operating modes	9
	2.2.5 Domestic Hot Water override	9
	2.2.6 Other information	10
3	Operating the appliance	11
	3.1 Browsing in the menus	11
	3.2 Reading out measured values	12
	3.3 Changing the settings	13
	3.3.1 Setting the set point temperatures	13
	3.3.2 Selecting the operating mode	14
	3.3.3 Forcing domestic hot water production	15
	3.3.4 Setting the contrast and lighting on the display	15
	3.3.5 Setting the time and date	16
	3.3.6 Selecting a timer programme	16
	3.3.7 Customising a timer programme	17
	3.3.8 Setting an annual clock	19

	3.4	Installation shutdown	21
	3.5	Antifreeze protection	21
4		Troubleshooting	22
	4.1	Messages (type code Mxx)	22
	4.2	Faults	22
5		Warranty	25
	5.1	General	25
	5.2	Warranty terms	25

1 Introduction

1.1 Symbols used

In these instructions, various danger levels are employed to draw the user's attention to particular information. In so doing, we wish to safeguard the user's safety, highlight hazards and guarantee correct operation of the appliance.



DANGER

Risk of a dangerous situation causing serious physical injury.



WARNING

Risk of a dangerous situation causing slight physical injury.



CAUTION

Risk of material damage.



Signals important information.



Signals a referral to other instructions or other pages in the instructions.

1.2 Abbreviations

- ▶ **DHW**: Domestic hot water
- ▶ **3WV**: 3-way valve

1.3 Liabilities

1.3.1. Manufacturer's liability

Our products are manufactured in compliance with the requirements of the various applicable European

Directives. They are therefore delivered with **CE** marking and all relevant documentation.

In the interest of customers, we are continuously endeavouring to make improvements in product quality. All the specifications stated in this document are therefore subject to change without notice.

Our liability as the manufacturer may not be invoked in the following cases:

- ▶ Failure to abide by the instructions on using the appliance.
- ▶ Faulty or insufficient maintenance of the appliance.
- ▶ Failure to abide by the instructions on installing the appliance.

1.3.2. Installer's liability

The installer is responsible for the installation and commissioning of the appliance. The installer must respect the following instructions:

- ▶ Read and follow the instructions given in the manuals provided with the appliance.
- ▶ Carry out installation in compliance with the prevailing legislation and standards.
- ▶ Perform the initial start up and carry out any checks necessary.
- ▶ Explain the installation to the user.
- ▶ If a maintenance is necessary, warn the user of the obligation to check the appliance and maintain it in good working order.
- ▶ Give all the instruction manuals to the user.

1.3.3. User's liability

To guarantee optimum operation of the appliance, the user must respect the following instructions:

- ▶ Read and follow the instructions given in the manuals provided with the appliance.
- ▶ Call on qualified professionals to carry out installation and initial start up.
- ▶ Get your installer to explain your installation to you.
- ▶ Ensure the Appliance is serviced in accordance with the manufacturer's instructions by a suitable qualified person.
- ▶ Keep the instruction manuals in good condition close to the appliance.

This appliance is not intended to be used by persons (including children) whose physical, sensory or mental capacity is impaired or persons with no experience or knowledge, unless they have the benefit, through the intermediary of a person responsible for their safety, of supervision or prior instructions regarding use of the appliance. Care should be taken to ensure that children do not play with the appliance.

If the mains power lead is damaged it must be replaced by the original manufacturer, the manufacturer's dealer or another competent person to prevent hazardous situations.

1.4 Certifications

This product complies to the requirements to the European directives and following standards:

- ▶ 2006/95/EC Low Voltage Directive. Reference Standard: EN60.335.1.
- ▶ 2004/108/EC Electromagnetic Compatibility Directive. Generic standards: EN1000-6-3 , EN 61000-6-1.

2 Description

2.1 Description of the keys

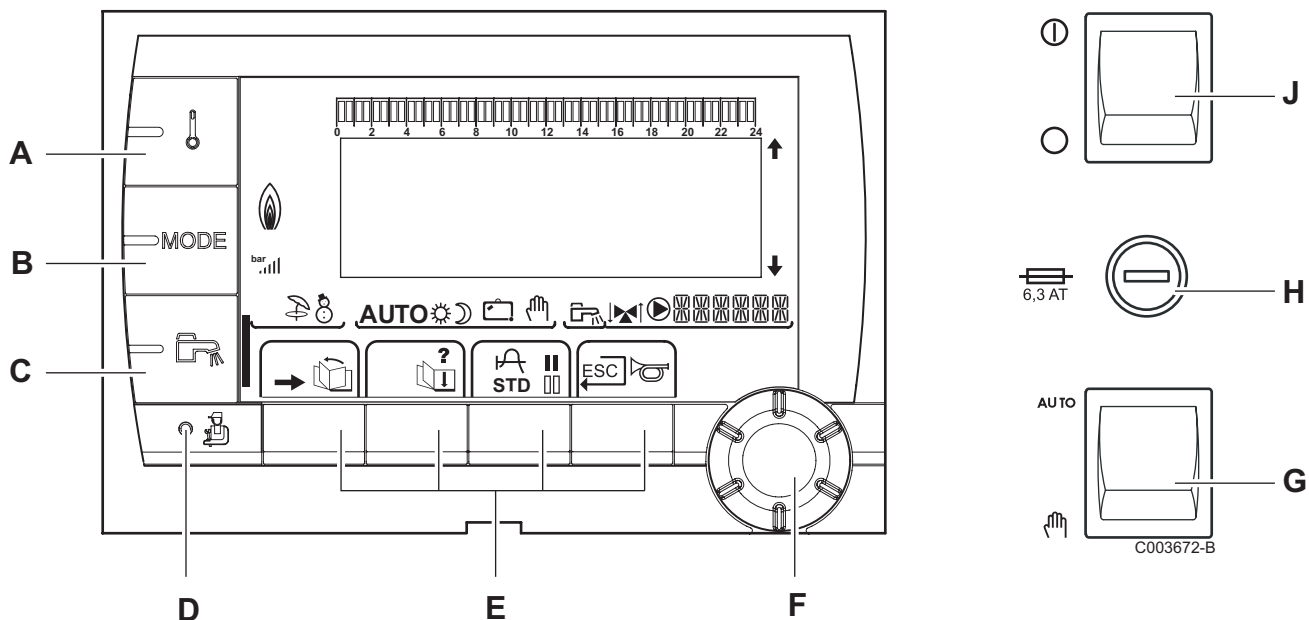

- A** Temperature setting key (heating, DHW, swimming pool)
- B** Operating mode selection key
- C** DHW override key
- D** Key to access the parameters reserved for the installer
- E** Keys on which the function varies as and when selections are made
- F** Rotary setting button:
 - ▶ Turn the rotary button to scroll through the menus or modify a value
 - ▶ Press the rotary button to access the selected menu or confirm a value modification
- G** Button AUTO/MANU
- H** Fuse
- J** Button ON/OFF

2.2 Description of the display

2.2.1. Key functions

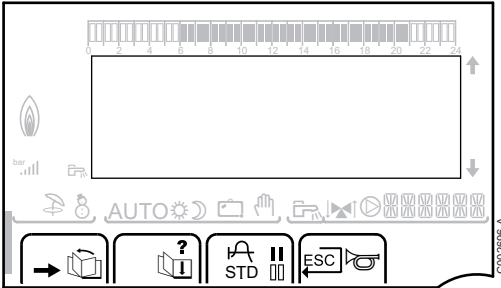

- Access to the various menus
- Used to scroll through the menus
- Used to scroll through the parameters
- ?
- The symbol is displayed when help is available
- Used to display the curve of the parameter selected
- STD** Reset of the time programmes
- Selection of comfort mode or selection of the days to be programmed
- Selection of reduced mode or deselection of the days to be programmed
- Back to the previous level
- ESC** Back to the previous level without saving the modifications made

2.2.2. Flame symbol

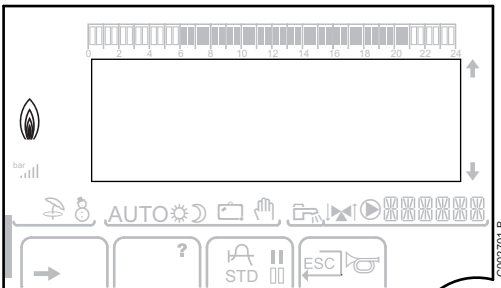

- ▶ The symbol is displayed: The burner is operating.
- ▶ The symbol is not displayed: The burner is off.

2.2.3. Solar (If connected)

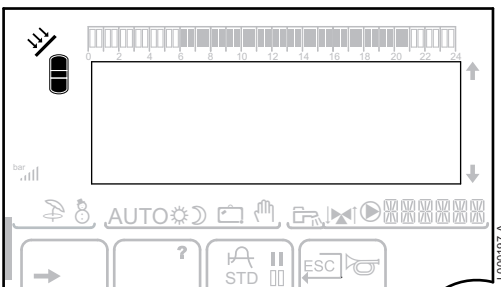

- The solar load pump is running
- The top part of the tank is reheated to the tank set point
- The entire tank is reheated to the tank set point
- The entire tank is reheated to the solar tank set point
- The tank is not loaded - Presence of the solar control system

2.2.4. Operating modes

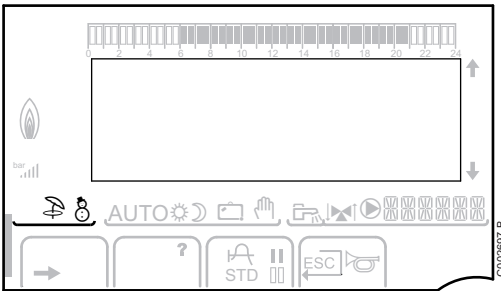

Summer mode: The heating is off. Domestic hot water continues to be produced

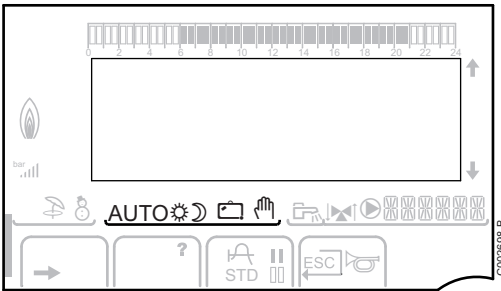

WINTER mode: Heating and domestic hot water working

AUTO

Operation in automatic mode according to the timer programme



Comfort mode: The symbol is displayed when a DAY override (comfort) is activated

- ▶ Flashing symbol: Temporary override
- ▶ Steady symbol: Permanent override



Reduced mode: The symbol is displayed when a NIGHT override (reduced) is activated

- ▶ Flashing symbol: Temporary override
- ▶ Steady symbol: Permanent override



Holiday mode: The symbol is displayed when a HOLIDAY override (antifreeze) is activated

- ▶ Flashing symbol: Holiday mode programmed
- ▶ Steady symbol: Holiday mode active



Manual mode: The boiler operates with the displayed set point. All of the pumps operate. The 3-way valves are not controlled.

2.2.5. Domestic Hot Water override

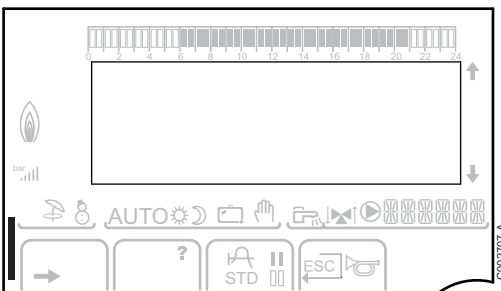





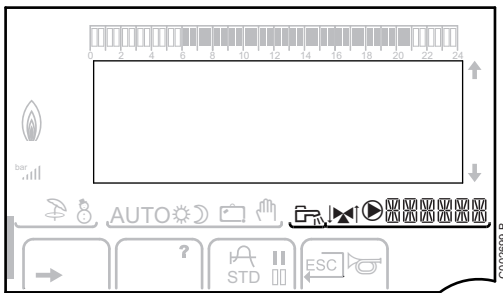

A bar is displayed when a DHW override is activated:

- ▶ Flashing bar: Temporary override
- ▶ Steady bar: Permanent override

2.2.6. Other information



-  The symbol is displayed when domestic hot water production is running.
-  Valve indicator: The symbol is displayed when a 3-way valve is connected.
 - ▶ : 3-way valve opens
 - ▶ : 3-way valve closes
-  The symbol is displayed when the pump is operating.
-  Name of the circuit for which the parameters are displayed.

3 Operating the appliance

3.1 Browsing in the menus

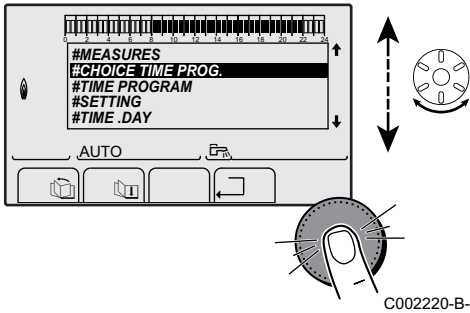

1. To select the desired menu, turn the rotary button.
2. To access the menu, press the rotary button.
To go back to the previous display, press the key \square .

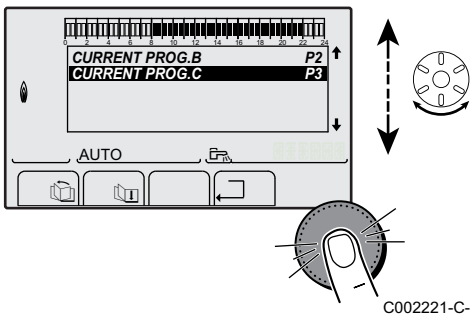

3. To select the desired parameter, turn the rotary button.
4. To modify the parameter, press the rotary button.
To go back to the previous display, press the key \square .

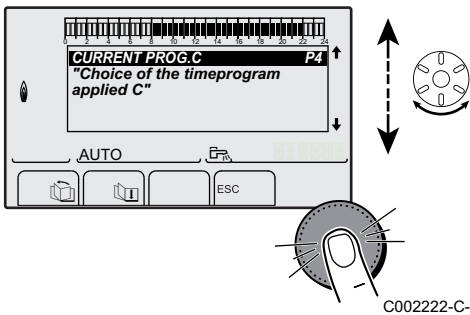

5. To modify the parameter, turn the rotary button.
6. To confirm, press the rotary button.

i To cancel, press key ESC.

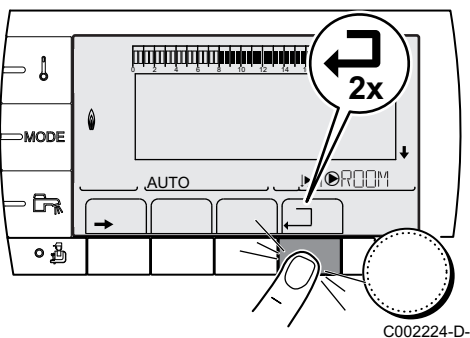

7. To go back to the main display, press key \square 2 times.

i It is possible to use the \square and \square keys instead of the rotary button.

3.2 Reading out measured values

The various values measured by the appliance are displayed in the **#MEASURES** menu.

1. To access user level: Press the → key.
2. Select the menu **#MEASURES**.



- ▶ Turn the rotary button to scroll through the menus or modify a value.
- ▶ Press the rotary button to access the selected menu or confirm a value modification.

For a detailed explanation of menu browsing, refer to the chapter: "Browsing in the menus", page 11.

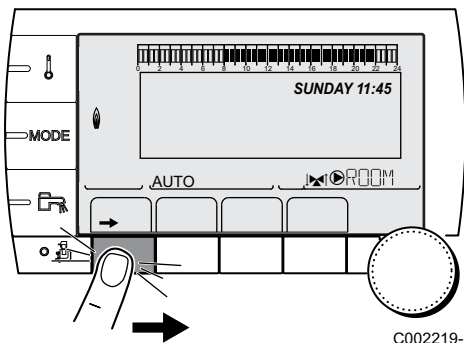

C002219-D-04

User level - #MEASURES menu		
Parameter	Description	Unit
OUTSIDE TEMP.	Outside temperature	°C
ROOMTEMP.B ⁽¹⁾	Room temperature of circuit B	°C
ROOMTEMP.C ⁽¹⁾	Room temperature of circuit C	°C
BOILER TEMP ⁽²⁾	Water temperature in the boiler	°C
WATER TEMP. ⁽¹⁾	Water temperature in the DHW tank	°C
STOR.TANK.TEMP ⁽¹⁾	Water temperature in the storage tank	°C
SWIMMING P.T.B ⁽¹⁾	Water temperature of the swimming pool on circuit B	°C
SWIMMING P.T.C ⁽¹⁾	Water temperature of the swimming pool on circuit C	°C
OUTLET TEMP.B ⁽¹⁾	Temperature of the flow water in circuit B	°C
OUTLET TEMP.C ⁽¹⁾	Temperature of the flow water in circuit C	°C
TEMP.SYSTEM ⁽¹⁾	Temperature of the system flow water if multi-generator	°C
T.DHW BOTTOM ⁽¹⁾	Water temperature in the bottom of the DHW tank	°C
TEMP.TANK AUX ⁽¹⁾	Water temperature in the second DHW tank connected to the AUX circuit	°C
TEMP.SOL.TANK ⁽¹⁾⁽²⁾	Temperature of the hot water produced by solar power (TS)	°C
SOLAR.COLL.T. ⁽¹⁾ ₍₂₎	Solar panel temperature (TC)	°C
SOLA.ENERGY ⁽¹⁾ ₍₂₎	Solar energy accumulated in the tank	kWh
IN 0-10V ⁽¹⁾⁽²⁾	Voltage at input 0-10 V	V
CTRL	Software control number	

⁽¹⁾ The parameter is only displayed for the options, circuits or sensors actually connected.
⁽²⁾ According to the configuration

3.3 Changing the settings

3.3.1. Setting the set point temperatures

To set the various heating, DHW and swimming pool temperatures, proceed as follows:

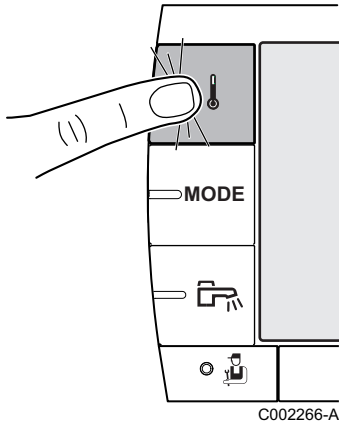

1. Press the ↓ key.
2. To select the desired parameter, turn the rotary button.
3. To modify the parameter, press the rotary button.
To go back to the previous display, press the key ↶.
4. To modify the parameter, turn the rotary button.
5. To confirm, press the rotary button.

i To cancel, press key ESC.

↓ Menu			
Parameter	Adjustment range	Description	Factory setting
DAY TEMP.B ⁽¹⁾	5 to 30 °C	Desired room temperature in comfort periods on circuit B	20 °C
NIGHT TEMP.B ⁽¹⁾	5 to 30 °C	Desired room temperature in reduced periods on circuit B	16 °C
DAY TEMP.C ⁽¹⁾	5 to 30 °C	Desired room temperature in comfort periods on circuit C	20 °C
NIGHT TEMP.C ⁽¹⁾	5 to 30 °C	Desired room temperature in reduced periods on circuit B	16 °C
TEMP.SOL.TANK ⁽¹⁾	20 to 80 °C	Maximum load temperature of the tank's solar zone	60°C
DHW TEMP. ⁽¹⁾	10 to 80 °C	Desired domestic hot water temperature in the DHW circuit	55 °C
TEMP.TANK AUX ⁽¹⁾	10 to 80 °C	Desired domestic hot water temperature in the auxiliary circuit	55 °C
SWIMMING P.T.B ⁽¹⁾	5 to 39 °C	Desired temperature for swimming pool B	20 °C
SWIMMING P.T.C ⁽¹⁾	5 to 39 °C	Desired temperature for swimming pool C	20 °C

(1) The parameter is only displayed for the options, circuits or sensors actually connected.

3.3.2. Selecting the operating mode

To select an operating mode, proceed as follows:

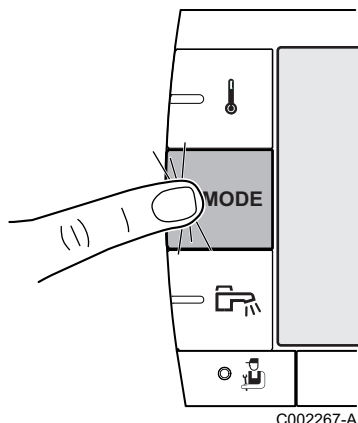

1. Press the **MODE** key.
2. To select the desired parameter, turn the rotary button.
3. To modify the parameter, press the rotary button.
To go back to the previous display, press the key \square .
4. To modify the parameter, turn the rotary button.
5. To confirm, press the rotary button.

i To cancel, press key **ESC**.

MODE Menu			
Parameter	Adjustment range	Description	Factory setting
AUTOMATIQUE		The comfort ranges are determined by the timer programme.	
DAY	7/7, xx:xx	Comfort mode is forced until the time indicated or all the time (7/7).	Present time + 1 hour
NIGHT	7/7, xx:xx	Reduced mode is forced until the time indicated or all the time (7/7).	Present time + 1 hour
HOLIDAYS	7/7, 1 to 364	The antifreeze mode is active on all boiler circuits. Number of days' holiday: xx ⁽¹⁾ heating OFF: xx:xx ⁽¹⁾ Restarting: xx:xx ⁽¹⁾	Present date + 1 day
SUMMER		The heating is off. Domestic hot water continues to be produced.	
MANUEL		The generator operates according to the set point setting. All of the pumps operate. Option of setting the set point by simply turning the rotary button.	
FORCE AUTO ⁽²⁾	YES / NO	An operating mode override is activated on the remote control (option). To force all circuits to run on AUTOMATIQUE mode, select YES .	

(1) The start and end days and the number of days are calculated in relation to each other.
 (2) The parameter is only displayed if a room sensor is connected.

3.3.3. Forcing domestic hot water production

To force domestic hot water production, proceed as follows:

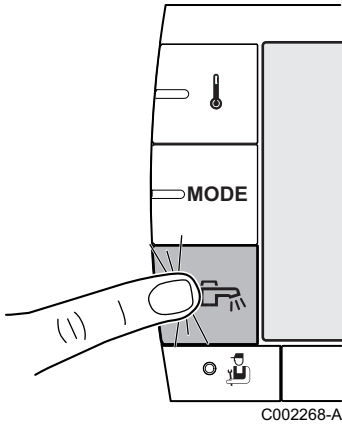

1. Press the key.
2. To select the desired parameter, turn the rotary button.
3. To modify the parameter, press the rotary button.
To go back to the previous display, press the key .
4. To modify the parameter, turn the rotary button.
5. To confirm, press the rotary button.

To cancel, press key **ESC**.

Menu		
Parameter	Description	Factory setting
AUTOMATIQUE	The domestic hot water comfort ranges are determined by the timer programme.	
COMFORT	Domestic hot water comfort mode is forced until the time indicated or all the time (7/7).	Present time + 1 hour

3.3.4. Setting the contrast and lighting on the display

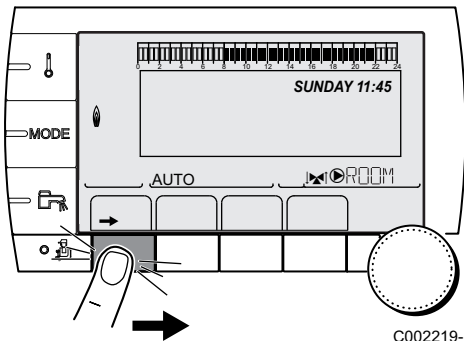

1. To access user level: Press the key.
2. Select the menu **#SETTING**.

Turn the rotary button to scroll through the menus or modify a value.

Press the rotary button to access the selected menu or confirm a value modification.

For a detailed explanation of menu browsing, refer to the chapter: "Browsing in the menus", page 11.

3. Set the following parameters:

User level - #SETTING Menu				
Parameter	Adjustment range	Description	Factory setting	Customer setting
CONTRAST DISP.		Adjusting the display contrast.		
BACK LIGHT	COMFORT	The screen is illuminated continuously in daytime periods.	ECO	
	ECO	The screen is illuminated for 2 minutes whenever pressed.		

3.3.5. Setting the time and date

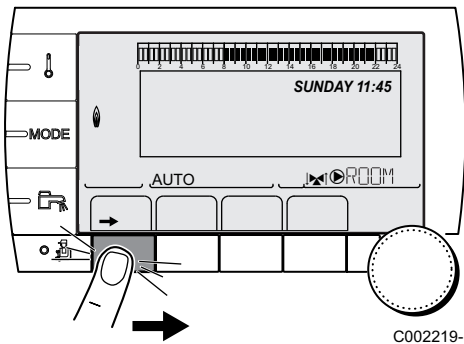

C002219-D-04

1. To access user level: Press the → key.
2. Select the menu #TIME .DAY.



- ▶ Turn the rotary button to scroll through the menus or modify a value.
- ▶ Press the rotary button to access the selected menu or confirm a value modification.

For a detailed explanation of menu browsing, refer to the chapter: "Browsing in the menus", page 11.

3. Set the following parameters:

User level - #TIME .DAY Menu (1)				
Parameter	Adjustment range	Description	Factory setting	Customer setting
HOURS	0 to 23	Hours setting		
MINUTE	0 to 59	Minutes setting		
DAY	Monday to Sunday	Setting the day of the week		
DATE	1 to 31	Day setting		
MONTH	January to December	Month setting		
YEAR	2008 to 2099	Year setting		
SUM.TIME	AUTO	automatic switch to summer time on the last Sunday in March and back to winter time on the last Sunday in October.	AUTO	
	MANU	for countries where the time change is done on other dates or is not in use.		

(1) According to the configuration

3.3.6. Selecting a timer programme

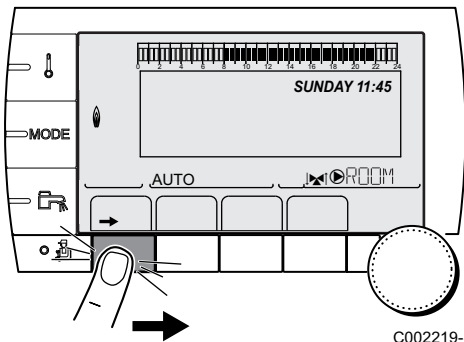

C002219-D-04

1. To access user level: Press the → key.
2. Select the menu #CHOICE TIME PROG..



- ▶ Turn the rotary button to scroll through the menus or modify a value.
- ▶ Press the rotary button to access the selected menu or confirm a value modification.

For a detailed explanation of menu browsing, refer to the chapter: "Browsing in the menus", page 11.

3. To select the desired parameter.

User level - #CHOICE TIME PROG. Menu		
Parameter	Adjustment range	Description
CURRENT PROG.B	P1 / P2 / P3 / P4	Comfort programme activated (Circuit B)
CURRENT PROG.C	P1 / P2 / P3 / P4	Comfort programme activated (Circuit C)

4. Assign the desired timer programme (P1 to P4) to the circuit with the rotary button.

3.3.7. Customising a timer programme

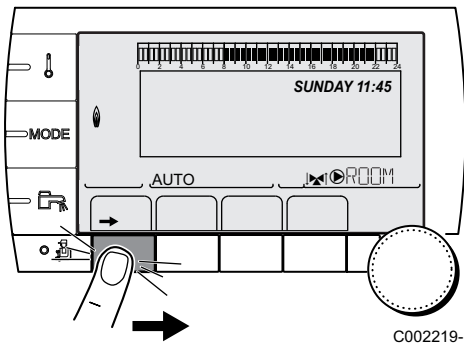

C002219-D-04

1. To access user level: Press the → key.
2. Select the menu **#TIME PROGRAM**.



- ▶ Turn the rotary button to scroll through the menus or modify a value.
- ▶ Press the rotary button to access the selected menu or confirm a value modification.

For a detailed explanation of menu browsing, refer to the chapter: "Browsing in the menus", page 11.

3. To select the desired parameter.

User level - #TIME PROGRAM Menu		
Parameter	Time schedule	Description
TIME PROG.B	PROG P2 B PROG P3 B PROG P4 B	Timer programme for circuit B
TIME PROG.C	PROG P2 C PROG P3 C PROG P4 C	Timer programme for circuit C
TIME PROG.DHW		DHW circuit timer programme
TIME PROG.AUX		Auxiliary circuit timer programme

4. To select a timer programme to be modified.
5. **To select to days for which the timer programme is to be modified:**
Turn the rotary button to the left until you reach the day desired. To confirm, press the rotary button.

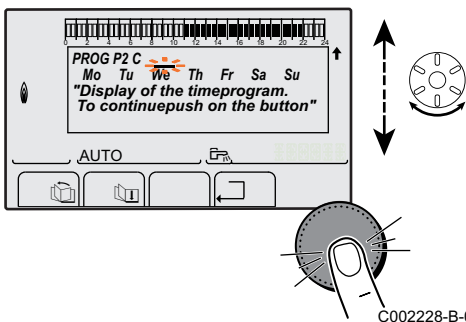

C002228-B-04

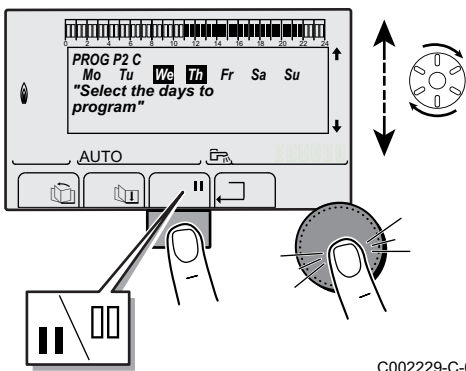

C002229-C-04

6. **||: Day selection**
Press key || / || until the symbol || is displayed.
Turn the rotary button to the right to select the day(s) desired.
||: Cancelling the day selection
Press key || / || until the symbol || is displayed.
Turn the rotary button to the right to cancel selection of the relevant day(s).
7. When the days desired for the programme have been selected, press the rotary button to confirm.

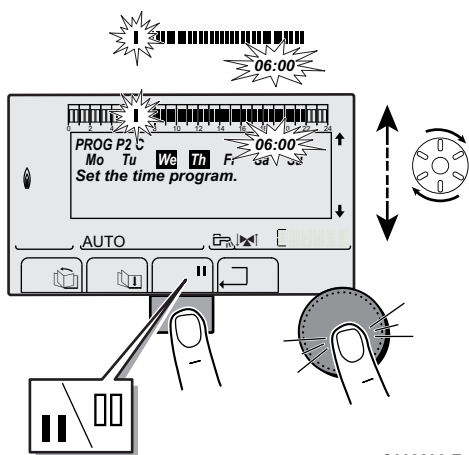

C002230-E-04

8. **To define the timer ranges for the comfort mode and reduced mode:**
Turn the rotary button to the left until **0:00** is displayed. The first segment of the graphic bar for the timer programme flashes.
9. **||: Comfort mode selection**
Press key **||** / **|||** until the symbol **||** is displayed.
To select a comfort time range, turn the rotary button to the right.
- |||: Reduced mode selection**
Press key **||** / **|||** until the symbol **|||** is displayed.
To select a reduced time range, turn the rotary button to the right.
10. When the times for the comfort mode have been selected, press the rotary button to confirm.

User level - #TIME PROGRAM Menu					
	Day	Comfort periods / Filling enabled:			
		P1 _____	P2 _____	P3 _____	P4 _____
TIME PROG.B	Monday	6:00 to 22:00			
	Tuesday	6:00 to 22:00			
	Wednesday	6:00 to 22:00			
	Thursday	6:00 to 22:00			
	Friday	6:00 to 22:00			
	Saturday	6:00 to 22:00			
	Sunday	6:00 to 22:00			
TIME PROG.C	Monday	6:00 to 22:00			
	Tuesday	6:00 to 22:00			
	Wednesday	6:00 to 22:00			
	Thursday	6:00 to 22:00			
	Friday	6:00 to 22:00			
	Saturday	6:00 to 22:00			
	Sunday	6:00 to 22:00			
TIME PROG.DHW	Monday				
	Tuesday				
	Wednesday				
	Thursday				
	Friday				
	Saturday				
	Sunday				
TIME PROG.AUX	Monday				
	Tuesday				
	Wednesday				
	Thursday				
	Friday				
	Saturday				
	Sunday				

3.3.8. Setting an annual clock

The annual clock is used to programme up to 10 heating stop periods over one year. The circuits selected for this stop are in Antifreeze mode during the period chosen.

1. To access user level: Press the → key.
2. Select the menu **#ANNUAL PROG**.



- ▶ Turn the rotary button to scroll through the menus or modify a value.
- ▶ Press the rotary button to access the selected menu or confirm a value modification.



For a detailed explanation of menu browsing, refer to the chapter: "Browsing in the menus", page 11.

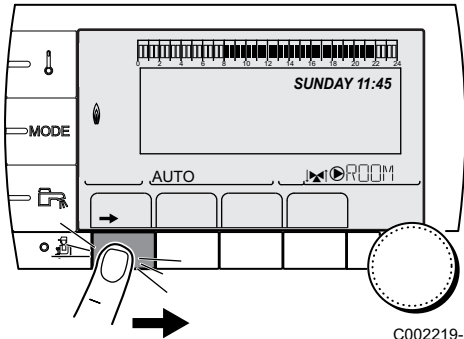

C002219-D-04

3. To select the desired parameter.

OFF	No stop
B	circuit B
C	circuit C
B+C	circuit B, C
SU	DHW circuit
B+E	circuit B and DHW
C+E	circuit C and DHW
ALL	circuit B, C and DHW

4. Set the start date and the end date of the shutdown selected.
5. To deactivate a shutdown, select the shutdown and set to **OFF**.
6. To select another shutdown, press the  button.

Annual programme (Factory setting)			
Stop no.	Circuit concerned	Start date	End date
1	OFF	01-01	01-01
2	OFF	01-01	01-01
3	OFF	01-01	01-01
4	OFF	01-01	01-01
5	OFF	01-01	01-01
6	OFF	01-01	01-01
7	OFF	01-01	01-01
8	OFF	01-01	01-01
9	OFF	01-01	01-01
10	OFF	01-01	01-01

For example: Customised programming			
Stop no.	Circuit concerned	Start date	End date
1	B+C	01-11	10-11
2	B+C	20-12	02-01

If setting **STOP: OFF**, the stop is deactivated and the start and end dates are not displayed.

User level - #ANNUAL PROG Menu				
		Description	Factory setting	Adjustment range
STOP N 1		Selection of the circuit stopped	OFF	OFF, B, C, B+C, SU, B+E, C+E, ALL
	BEG.DATE N 01	Setting start date of the stop	01	1-31
	BEG.MONTH N 01	Setting start month of the stop	01	1-12
	END DATE N 01	Setting end date of the stop	01	1-31
	END MONTH N 01	Setting end month of the stop	01	1-12
STOP N 2		Selection of the circuit stopped	OFF	OFF, B, C, B+C, SU, B+E, C+E, ALL
	BEG.DATE N 02	Setting start date of the stop	01	1-31
	BEG.MONTH N 02	Setting start month of the stop	01	1-12
	END DATE N 02	Setting end date of the stop	01	1-31
	END MONTH N 02	Setting end month of the stop	01	1-12
STOP N 3		Selection of the circuit stopped	OFF	OFF, B, C, B+C, SU, B+E, C+E, ALL
	BEG.DATE N 03	Setting start date of the stop	01	1-31
	BEG.MONTH N 03	Setting start month of the stop	01	1-12
	END DATE N 03	Setting end date of the stop	01	1-31
	END MONTH N 03	Setting end month of the stop	01	1-12
STOP N 4		Selection of the circuit stopped	OFF	OFF, B, C, B+C, SU, B+E, C+E, ALL
	BEG.DATE N 04	Setting start date of the stop	01	1-31
	BEG.MONTH N 04	Setting start month of the stop	01	1-12
	END DATE N 04	Setting end date of the stop	01	1-31
	END MONTH N 04	Setting end month of the stop	01	1-12
STOP N 5		Selection of the circuit stopped	OFF	OFF, B, C, B+C, SU, B+E, C+E, ALL
	BEG.DATE N 05	Setting start date of the stop	01	1-31
	BEG.MONTH N 05	Setting start month of the stop	01	1-12
	END DATE N 05	Setting end date of the stop	01	1-31
	END MONTH N 05	Setting end month of the stop	01	1-12
STOP N 6		Selection of the circuit stopped	OFF	OFF, B, C, B+C, SU, B+E, C+E, ALL
	BEG.DATE N 06	Setting start date of the stop	01	1-31
	BEG.MONTH N 06	Setting start month of the stop	01	1-12
	END DATE N 06	Setting end date of the stop	01	1-31
	END MONTH N 06	Setting end month of the stop	01	1-12
STOP N 7		Selection of the circuit stopped	OFF	OFF, B, C, B+C, SU, B+E, C+E, ALL
	BEG.DATE N 07	Setting start date of the stop	01	1-31
	BEG.MONTH N 07	Setting start month of the stop	01	1-12
	END DATE N 07	Setting end date of the stop	01	1-31
	END MONTH N 07	Setting end month of the stop	01	1-12
STOP N 8		Selection of the circuit stopped	OFF	OFF, B, C, B+C, SU, B+E, C+E, ALL
	BEG.DATE N 08	Setting start date of the stop	01	1-31
	BEG.MONTH N 08	Setting start month of the stop	01	1-12
	END DATE N 08	Setting end date of the stop	01	1-31
	END MONTH N 08	Setting end month of the stop	01	1-12
STOP N 9		Selection of the circuit stopped	OFF	OFF, B, C, B+C, SU, B+E, C+E, ALL
	BEG.DATE N 09	Setting start date of the stop	01	1-31
	BEG.MONTH N 09	Setting start month of the stop	01	1-12
	END DATE N 09	Setting end date of the stop	01	1-31
	END MONTH N 09	Setting end month of the stop	01	1-12
STOP N 10		Selection of the circuit stopped	OFF	OFF, B, C, B+C, SU, B+E, C+E, ALL
	BEG.DATE N 10	Setting start date of the stop	01	1-31
	BEG.MONTH N 10	Setting start month of the stop	01	1-12
	END DATE N 10	Setting end date of the stop	01	1-31
	END MONTH N 10	Setting end month of the stop	01	1-12

3.4 Installation shutdown



CAUTION

Do not switch off the mains supply to the appliance. If the central heating system is not used for a long period, we recommend activating the **HOLIDAYS** mode (to ensure the anti-grip of the heating pump).

3.5 Antifreeze protection



CAUTION

- ▶ The antifreeze protection does not function if the appliance is switched off.
- ▶ To protect the installation, set the appliance to **HOLIDAYS** mode.

The **HOLIDAYS** mode protects:

- ▶ The installation if the outside temperature is lower than 3 °C (factory setting).
- ▶ The room temperature if a remote control is connected and the room temperature is lower than 6 °C (factory setting).
- ▶ The domestic hot water tank if the tank temperature is lower than 4 °C (the water is reheated to 10 °C).

To configure the holidays mode:  See chapter: "Selecting the operating mode", page 14.

4 Troubleshooting

4.1 Messages (type code Mxx)

The module may display the following messages:

Code no.	Messages	Description	Checking / solution
	FL.DRY.B XX DAYS	Floor drying is active XX DAYS = Number of days' floor drying remaining.	Floor drying is underway. Heating on the circuits not concerned is shut down. ▶ Contact the professional who takes care of maintenance of the appliance.
	FL.DRY.C XX DAYS		
	FL.DRY.B+C XX DAYS		
	STOP N XX	The shutdown is active XX = Number of the active shutdown	A shutdown is underway. The circuits selected for this stop are in Antifreeze mode during the period chosen.
M23	CHANGE OUTSI.S	The outside temperature sensor is defective.	Change the outside radio temperature sensor.
M30	BL.COM MODBUS	No communication with the master regulation through the MODBUS network.	Contact the professional who takes care of maintenance of the appliance.
M31	BL.SYSTEM NETWORK	Incorrect configuration of the MODBUS network.	Contact the professional who takes care of maintenance of the appliance.

4.2 Faults

If a malfunction occurs, the module flashes and displays an error message and a corresponding code.

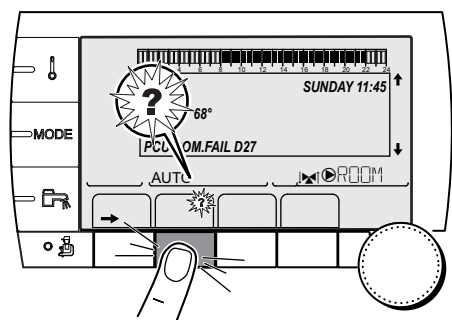

C002302-D-04

1. Make a note of the code displayed.
The code is important for the correct and rapid diagnosis of the type of failure and for any technical assistance that may be needed.
2. Press the ? key. Follow the instructions displayed to solve the problem.
3. Consult the meaning of the codes in the table below:

Code	Faults	Description	Checking / solution
D03 D04	OUTL S.B FAIL. OUTL S.C FAIL.	Circuit B flow sensor fault Circuit C flow sensor fault Remarks: The circuit pump is running. The 3-way valve motor on the circuit is no longer powered and can be adjusted manually.	Bad connection Sensor fault ▶ Contact the professional who takes care of maintenance of the appliance
D05	OUTSI.S.FAIL.	Outside temperature sensor fault Remarks: The set point of the appliance is equal to the maximum. The valve setting is no longer ensured but monitoring the maximum temperature of the circuit after the valve is ensured. Valves may be manually operated. Reheating the domestic hot water remains ensured.	Bad connection Sensor fault ▶ Contact the professional who takes care of maintenance of the appliance
D07	SYST.SENS.FAIL.	System sensor fault	Bad connection Sensor fault ▶ Contact the professional who takes care of maintenance of the appliance
D09	DHW S.FAILURE	Domestic hot water sensor fault Remarks: Heating of domestic hot water is no longer ensured. The load pump operates. The load temperature of the dhw tank is the same as the boiler.	Bad connection Sensor fault ▶ Contact the professional who takes care of maintenance of the appliance
D12 D13	ROOM S.B FAIL. ROOM S.C FAIL.	B room temperature sensor fault C room temperature sensor fault Note: The circuit concerned operates without any influence from the room sensor.	Bad connection Sensor fault ▶ Contact the professional who takes care of maintenance of the appliance
D14	MC COM.FAIL	Break in communication between the iSense Pro module and the boiler radio module	Bad connection ▶ Check the link and the connectors Boiler module failure ▶ Change the boiler module
D15	ST.TANK S.FAIL	Storage tank sensor fault Note: The hot water storage tank reheating operation is no longer assured.	Bad connection Sensor fault ▶ Contact the professional who takes care of maintenance of the appliance
D16	SWIM.B S.FAIL SWIM.C S.FAIL	Swimming pool sensor fault circuit B Swimming pool sensor fault circuit C Note: Pool reheating is independent of its temperature.	Bad connection Sensor fault ▶ Contact the professional who takes care of maintenance of the appliance
D17	DHW 2 S.FAIL	Sensor fault tank 2	Bad connection Sensor fault ▶ Contact the professional who takes care of maintenance of the appliance
D18	ST.TANK S.FAIL	Solar tank sensor fault	Bad connection Sensor fault ▶ Contact the professional who takes care of maintenance of the appliance
D19	SOL.COL.S.FAIL	Header sensor fault	Bad connection Sensor fault ▶ Contact the professional who takes care of maintenance of the appliance

Code	Faults	Description	Checking / solution
D20	SOL COM.FAIL	Interruption in communication between the SCU PCB and the solar control system ▶ Contact the professional who takes care of maintenance of the appliance	
D50	OTH COM.FAIL	Break in communication between the iSense Pro module and the boiler control panel.	▶ Contact the professional who takes care of maintenance of the appliance.
D51	DEF XX:SEE BOIL.	An error is displayed on the boiler control panel.	▶ Refer to the boiler's installation and service manual.

5 Warranty

5.1 General

You have just purchased one of our appliances and we thank you for the trust you have placed in our products.

Please note that your appliance will provide good service for a longer period of time if it is regularly checked and maintained.

Your installer and our customer support network are at your disposal at all times.

5.2 Warranty terms

The following provisions are not exclusive of the buyer being able benefit from the legal provisions applicable regarding hidden defects in the buyer's country.

Starting from the purchase date shown on the original installer's invoice, your appliance has a contractual guarantee against any manufacturing defect.

The length of the guarantee is mentioned in the price catalogue. The manufacturer is not liable for any improper use of the appliance or failure to maintain or install the unit correctly (the user shall take care to ensure that the system is installed by a qualified engineer).

In particular, the manufacturer shall not be held responsible for any damage, loss or injury caused by installations which do not comply with the following:

- ▶ applicable local laws and regulations,
- ▶ specific requirements relating to the installation, such as national and/or local regulations,
- ▶ the manufacturer's instructions, in particular those relating to the regular maintenance of the unit,
- ▶ the rules of the profession.

The warranty is limited to the exchange or repair of such parts as have been recognised to be faulty by our technical department and does not cover labour, travel and carriage costs.

The warranty shall not apply to the replacement or repair of parts damaged by normal wear and tear, negligence, repairs by unqualified parties, faulty or insufficient monitoring and maintenance, faulty power supply or the use of unsuitable fuel.

Sub-assemblies such as motors, pumps, electric valves etc. are guaranteed only if they have never been dismantled.

The legislation laid down by european directive 99/44/EEC, transposed by legislative decree No. 24 of 2 February 2002 published in O.J. No. 57 of 8 March 2002, continues to apply.

Remeha Commercial UK
Innovations House
3 Oaklands Business Centre
Oaklands Park
RG41 2FD WOKINGHAM,

Tel: +44 118 9783434
Fax: +44 118 9786977
Internet: www.remeha.co.uk
E-mail: boilers@remeha.co.uk.



© Copyright

All technical and technological information contained in these technical instructions, as well as any drawings and technical descriptions supplied, remain our property and shall not be multiplied without our prior consent in writing.

07/01/2015



300027285-001-02

 **remeha**

The Remeha logo symbol is a stylized 'R' inside a square frame. The word 'remeha' is written in a bold, lowercase, sans-serif font.